

A405G10

printed on: 19-09-2024



TECHNICAL INFO

Media type	INORGANIC FIBERGLASS
Efficiency	10 $\mu\text{m}_{(c)}$ $\beta_x \geq 200$
Efficiency 1	12 $\mu\text{m}_{(c)}$ $\beta_x \geq 1000$
Max working pressure	34.5 bar
Seals	NBR
Temperature range	-30°C +100°C

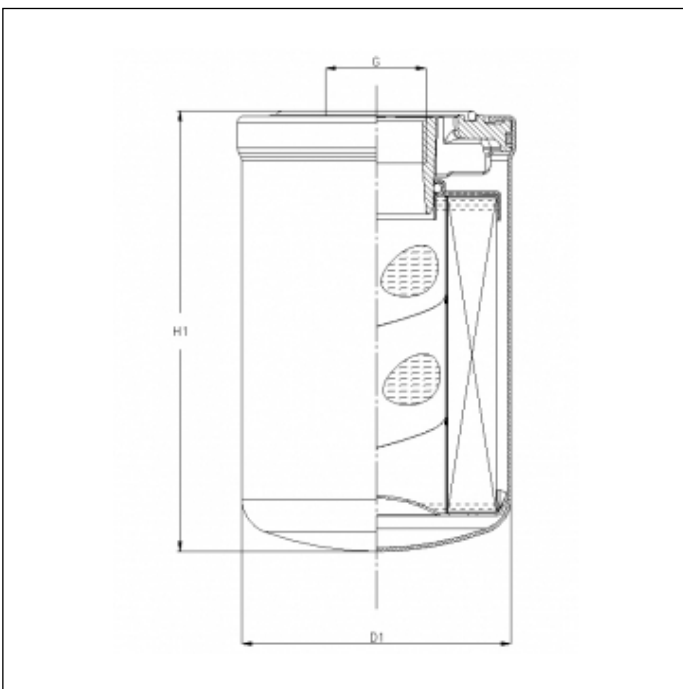

OVERALL DIMENSIONS

D1	95,0 mm
H1	101,0 mm
G	1 3/8"-12 UNF 2B

Technical information may change without notice. Image and drawing are representative only