

## A421G40

printed on: 29-12-2024



### TECHNICAL INFO

Media type	INORGANIC FIBERGLASS
Efficiency	32 $\mu\text{m}_{(c)}$ $\beta_x \geq 200$
Efficiency 1	35 $\mu\text{m}_{(c)}$ $\beta_x \geq 1000$
Max working pressure	24 bar
Seals	NBR
Temperature range	-30°C +100°C

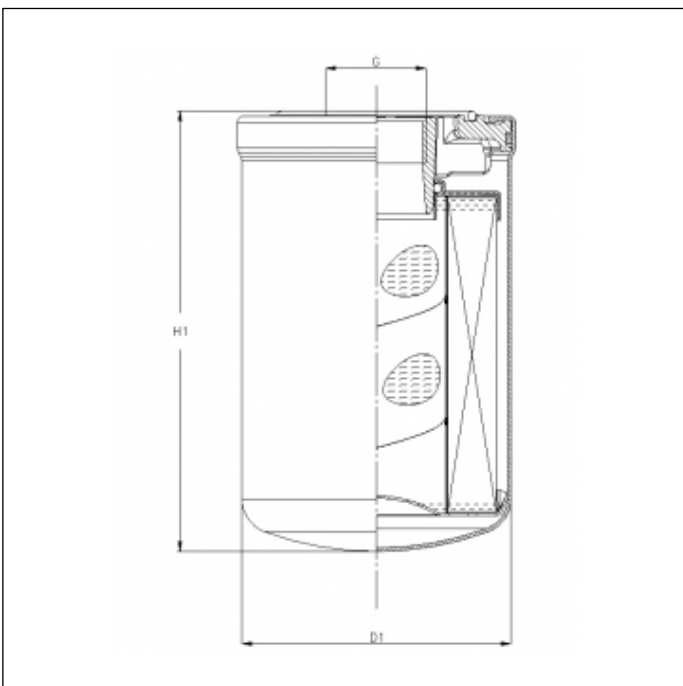

### OVERALL DIMENSIONS

D1	117,0 mm
H1	297,5 mm
G	1 3/4"-12 UN 2B

Technical information may change without notice. Image and drawing are representative only