

Series 104

General

The micro valves 104 series are a cost effective solution with reduced overall dimensions, easy to install and manage. Their main characteristic is the possibility to choose between the version with lateral or rear pneumatic connections realized with quick fitting for Ø4mm tube included.

The valves are available with 2 or 3 ways versions, normally closed or open, 5 ways and 5 ways 3 positions open centres and pressured centres.

The 5 ways version is made with two 3 ways valves placed side by side with common inlet.

The operators available for this valve are push button (different versions), selector (key, short and long lever), lever (lever roller or level unidirectional) and pneumatic.

It is also possible to combine the 2 and 3 ways valves with electrical switches, normally closed or open.

Construction characteristics

Body and cover	Technopolymer
Operators	Plastic material for buttons and switches
Seals	NBR
Spacer	Technopolymer
Spools	Steel
Springs	Spring steel
Pistons	Aluminium (for pneumatic command version)

Use and maintenance

This valves have an average life of 15 million cycles depending on the application and air quality.

Filtered and lubricated air using specified lubricants will reduce the wear of the seals and ensures long and trouble free operation.

Please ensure that the valve is being used according with the manufacturers specification, such as air pressure and temperature.

ATTENTION: use hydraulic oil class H for lubrication such as MAGNA GC 32 (Castrol).

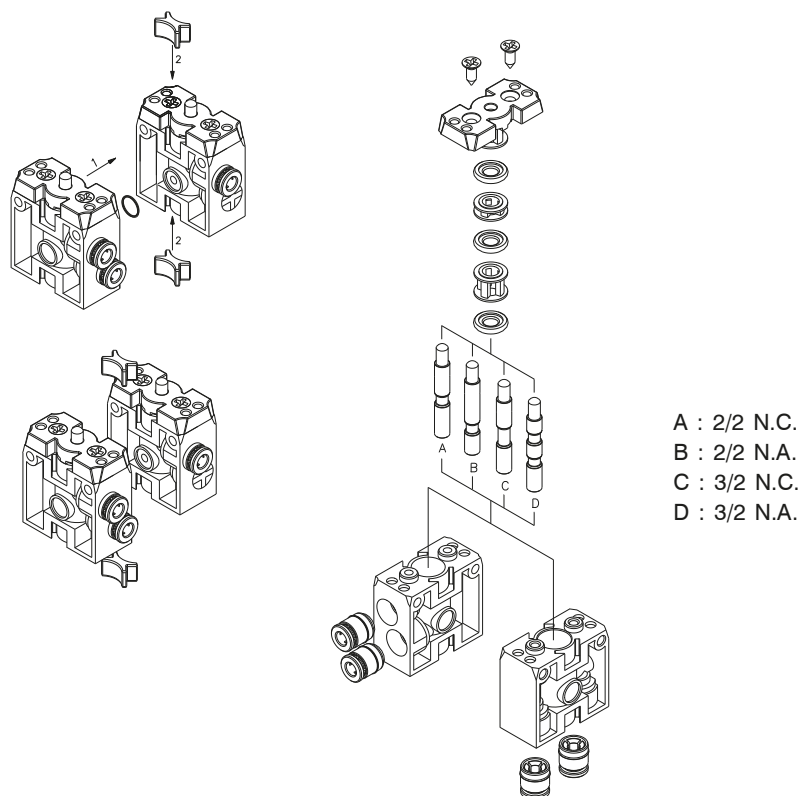



1
AIR DISTRIBUTION

Tappet - Spring

Coding: 104.●.0.1.●.●.●

Operational characteristics

Fluid	Filtered air. No lubrication needed, if applied it shall be continuous
Max working pressure (bar)	10
Temperature °C	-5 ÷ +70
Flow rate at 6 bar with Δp=1 (NI/min)	90
Orifice size (mm)	2.5
Working ports size	ø4 tube

TYPE	FUNCTION
● 22 = 2 ways	● A = Normally Open
● 32 = 3 ways	● C = Normally Closed
CONNECTION TYPE	
● L = Lateral	
● P = Rear	

2/2 - 3/2 - Lateral connections

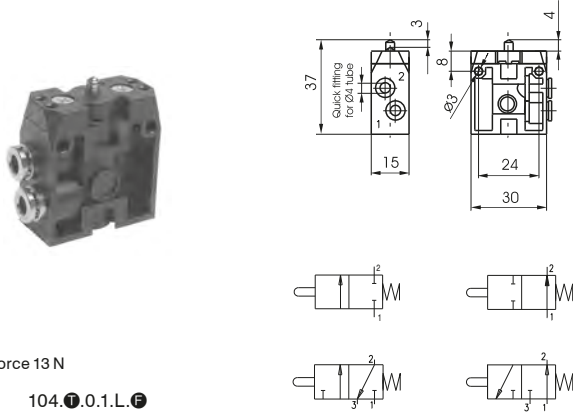

Weight 20 g
Operating force 13 N

104.●.0.1.L.●

2/2 - 3/2 - Rear connections

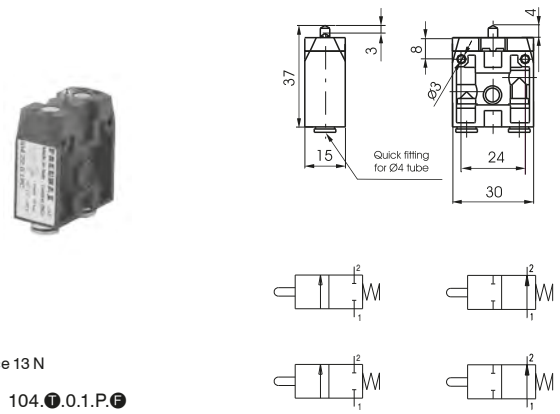

Weight 20 g
Operating force 13 N

104.●.0.1.P.●

Push button - Spring

Coding: 104.●.6.22/●.●.●.●

Operational characteristics

Fluid	Filtered air. No lubrication needed, if applied it shall be continuous
Max working pressure (bar)	10
Temperature °C	-5 ÷ +70
Flow rate at 6 bar with Δp=1 (NI/min)	90
Orifice size (mm)	2.5
Working ports size	ø4 tube

TYPE	CONNECTION TYPE
● 22 = 2 ways	● L = Lateral
● 32 = 3 ways	● P = Rear
● 52 = 5 ways	FUNCTION (only for 2 or 3 ways)
BUTTON COLOR	● A = Normally Open
● 1 = Red	● C = Normally Closed
● 2 = Black	
● 3 = Green	
● 4 = Yellow	

2/2 - 3/2 - Lateral connections

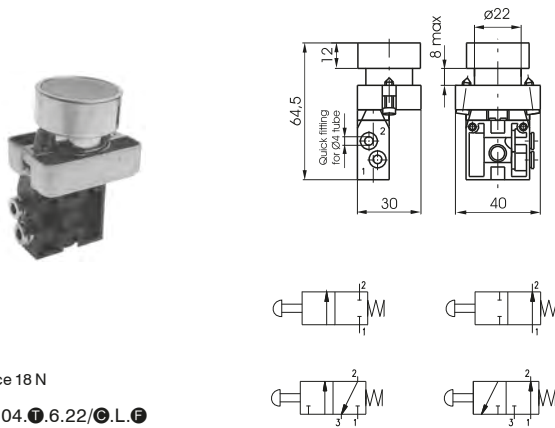

Weight 50 g
Operating force 18 N

104.●.6.22/●.L.●

2/2 - 3/2 - Rear connections

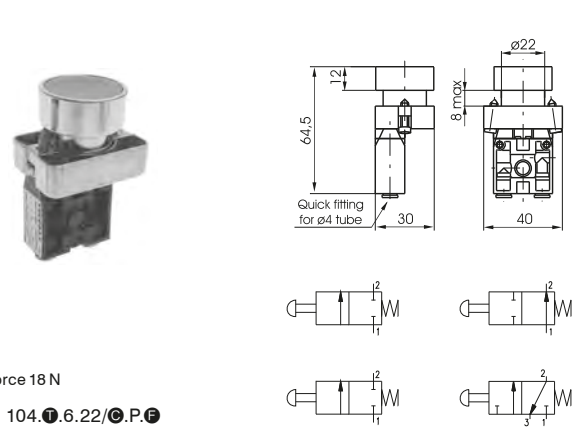

Weight 50 g
Operating force 18 N

104.●.6.22/●.P.●

5/2 - Lateral connections

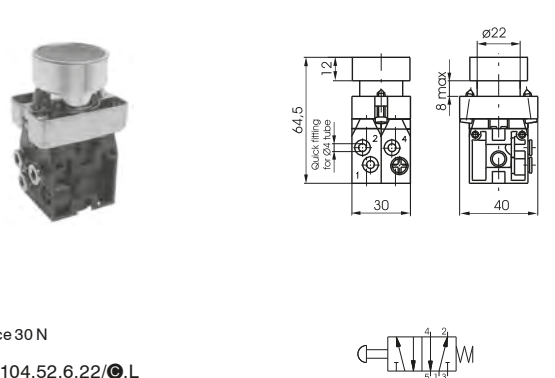

Weight 105 g
Operating force 30 N

104.52.6.22/●.L

5/2 - Rear connections

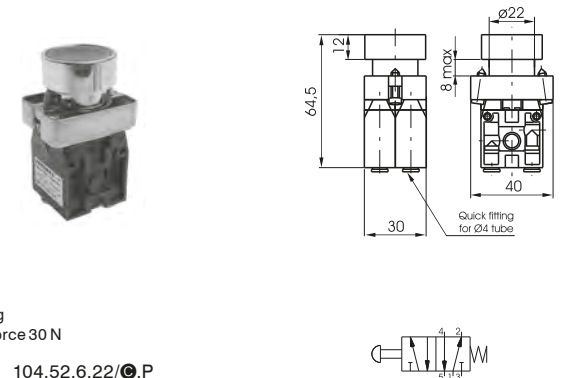

Weight 105 g
Operating force 30 N

104.52.6.22/●.P

Push button 2 positions (step - step)

Coding: 104. **T**.6.31. **W**. **F**

Operational characteristics	
Fluid	Filtered air. No lubrication needed, if applied it shall be continuous
Max working pressure (bar)	10
Temperature °C	-5 ÷ +70
Flow rate at 6 bar with $\Delta p=1$ (Nl/min)	90
Orifice size (mm)	2.5
Working ports size	ø4 tube

T	TYPE
	22 = 2 ways
	32 = 3 ways
W	CONNECTION TYPE
	L = Lateral
	P = Rear

F	FUNCTION (only for 2/2 and 3/2 ways)
	A = Normally Open
	C = Normally Closed

2/2 - 3/2 - Lateral connections

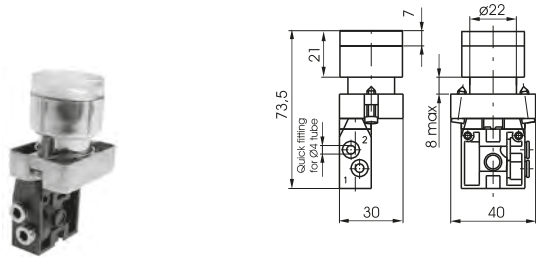

Weight 60 g
Operating force 18 N

104. **T**.6.31. **L**. **F**

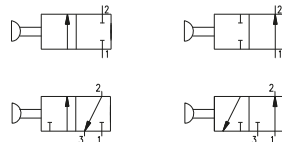

2/2 - 3/2 - Rear connections

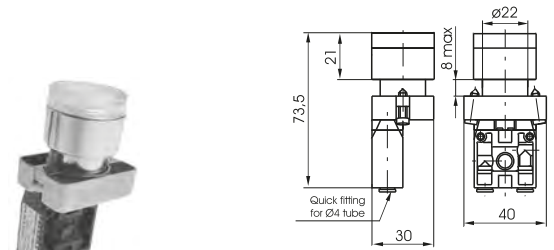

Weight 60 g
Operating force 18 N

104. **T**.6.31. **P**. **F**

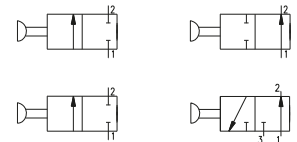

5/2 - Lateral connections

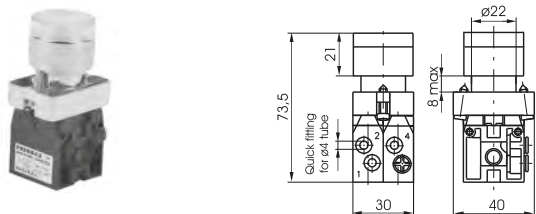

Weight 110 g
Operating force 30 N

104.52.6.31.L

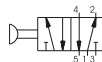

5/2 - Rear connections

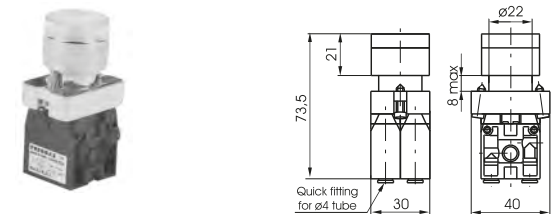

Weight 110 g
Operating force 30 N

104.52.6.31.P

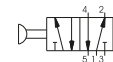

1
AIR DISTRIBUTION



Raised Push button - Spring

Coding: 104. **T**.6.23/**C**.**W**.**F**

Operational characteristics

Fluid	Filtered air. No lubrication needed, if applied it shall be continuous
Max working pressure (bar)	10
Temperature °C	-5 ÷ +70
Flow rate at 6 bar with $\Delta p=1$ (Nl/min)	90
Orifice size (mm)	2.5
Working ports size	$\varnothing 4$ tube

T	TYPE	W	CONNECTION TYPE	
	22 = 2 ways		L = Lateral	
	32 = 3 ways		P = Rear	
C	52 = 5 ways	F	FUNCTION (only for 2 or 3 ways)	
	BUTTON COLOR		A = Normally Open	
	1 = Red		C = Normally Closed	
	2 = Black			
	3 = Green			
	4 = Yellow			

1
AIR DISTRIBUTION

2/2 - 3/2 - Lateral connections

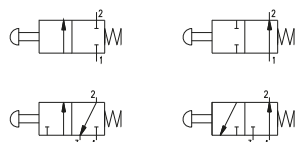
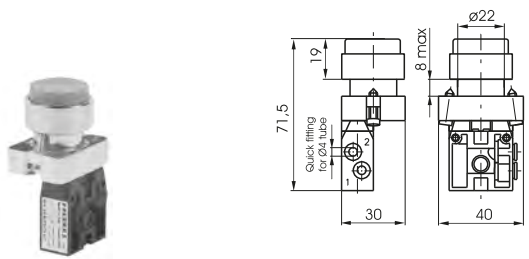

Weight 50 g
Operating force 18 N

104. **T**.6.23/**C**.**L**.**F**

2/2 - 3/2 - Rear connections

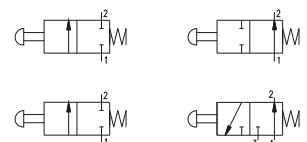
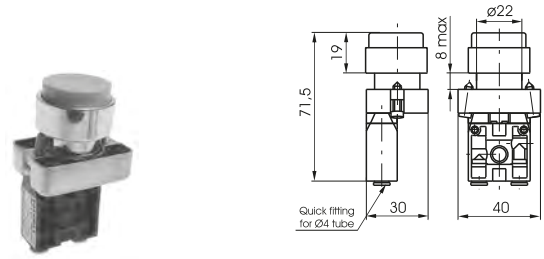

Weight 50 g
Operating force 18 N

104. **T**.6.23/**C**.**P**.**F**

5/2 - Lateral connections

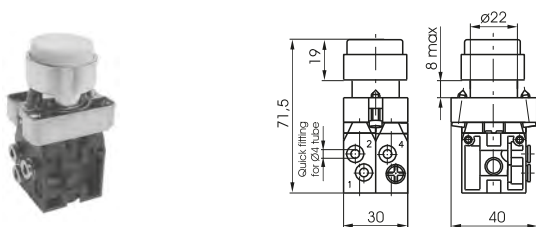

Weight 105 g
Operating force 30 N

104.52.6.23/**C**.**L**

5/2 - Rear connections

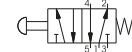
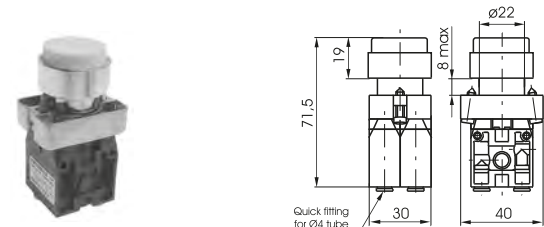

Weight 105 g
Operating force 30 N

104.52.6.23/**C**.**P**

Palm button 2 position

Coding: 104. **T**.6.25. **W**. **F**

Operational characteristics	
Fluid	Filtered air. No lubrication needed, if applied it shall be continuous
Max working pressure (bar)	10
Temperature °C	-5 ÷ +70
Flow rate at 6 bar with Δp=1 (Nl/min)	90
Orifice size (mm)	2.5
Working ports size	ø4 tube

T	TYPE
	22 = 2 ways
	32 = 3 ways
W	CONNECTION TYPE
	L = Lateral
	P = Rear

F	FUNCTION (only for 2/2 and 3/2 ways)
	A = Normally Open
	C = Normally Closed

2/2 - 3/2 - Lateral connections

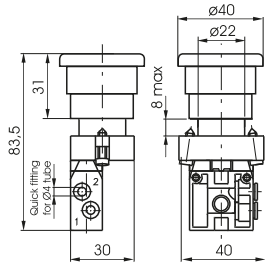

Weight 65 g
Operating force 19 N
Emergency - Rotate to unlock

104. **T**.6.25. **L**. **F**

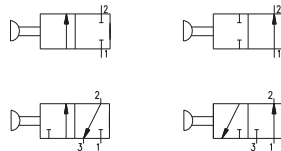

2/2 - 3/2 - Rear connections

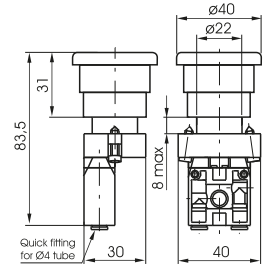

Weight 65 g
Operating force 19 N
Emergency - Rotate to unlock

104. **T**.6.25. **P**. **F**

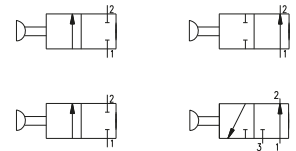

5/2 - Lateral connections

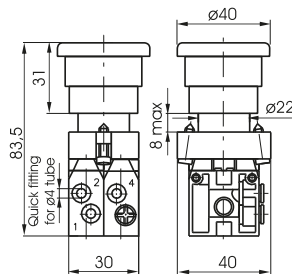

Weight 120 g
Operating force 32 N
Emergency - Rotate to unlock

104.52.6.25. **L**

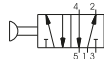

5/2 - Rear connections

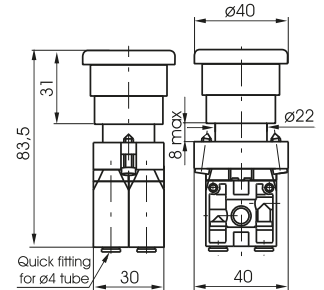

Weight 120 g
Operating force 32 N
Emergency - Rotate to unlock

104.52.6.25. **P**

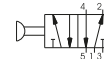

1
AIR DISTRIBUTION

Switch - short lever

Coding: 104. **T**. **F**. 1.6.30. **S**. **W**. **F**2

Operational characteristics

Fluid	Filtered air. No lubrication needed, if applied it shall be continuous
Max working pressure (bar)	10
Temperature °C	-5 ÷ +70
Flow rate at 6 bar with Δp=1 (NI/min)	90
Orifice size (mm)	2.5
Working ports size	ø4 tube

T	TYPE	S	SWITCH POSITION (only for 2/2 and 3/2 ways)
	22 = 2 ways		0 = 3 pos. instable
	32 = 3 ways		1 = 3 pos. stable
	52 = 5 ways		
F 1	FUNCTION (only for 5/3 ways)	W	CONNECTION TYPE
	32 = Open centres		L = Lateral
	33 = Pressured centres		P = Rear
		F 2	FUNCTION (only for 2/2 or 3/2 ways)
			A = Normally Open
			C = Normally Closed

AIR DISTRIBUTION

2/2 - 3/2 - Lateral connections

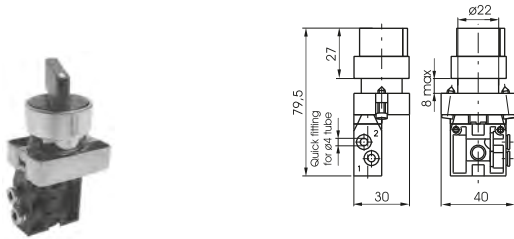

Weight 65 g
Switch 2 positions stable

104. **T**. **F**. 6.30. **L**. **F**

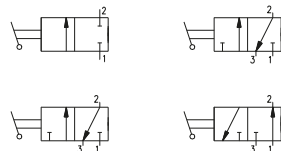

2/2 - 3/2 - Rear connections

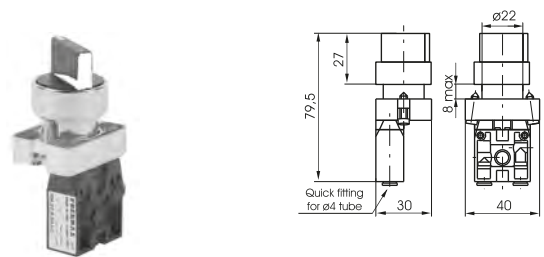

Weight 65 g
Switch 2 positions stable

104. **T**. 6.30. **P**. **F**

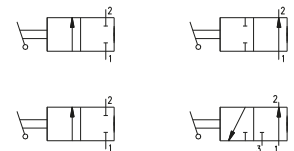

5/2 - Lateral connections

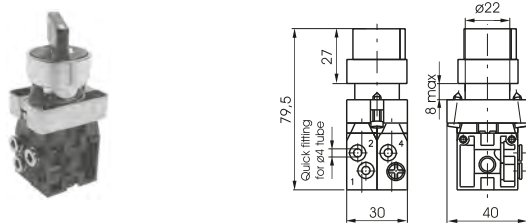

Weight 120 g
Switch 2 positions stable

104.52.6.30.L

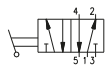

5/2 - Rear connections

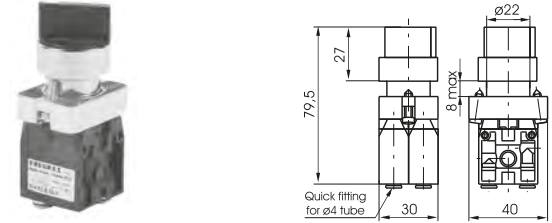

Weight 120 g
Switch 2 positions stable

104.52.6.30.P

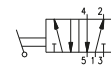

5/3 - Lateral connections

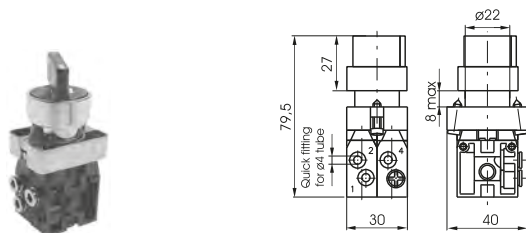

Weight 120 g

104.53. **F**. 6.30. **S**. **L**

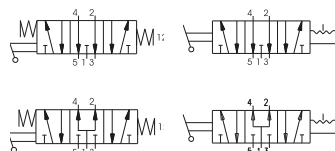

5/3 - Rear connections

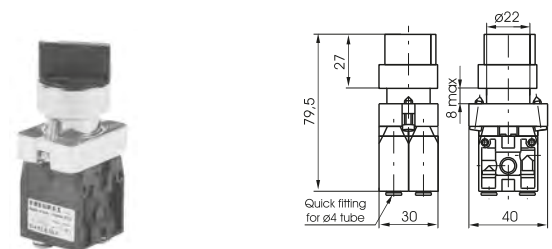

Weight 120 g

104.53. **F**. 6.30. **S**. **P**

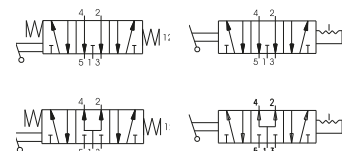

Switch - long lever

Coding: 104. **T**. **F**1.6.27. **S**. **W**. **F**2

Operational characteristics	
Fluid	Filtered air. No lubrication needed, if applied it shall be continuous
Max working pressure (bar)	10
Temperature °C	-5 ÷ +70
Flow rate at 6 bar with Δp=1 (Nl/min)	90
Orifice size (mm)	2.5
Working ports size	ø4 tube

T	TYPE	S	SWITCH POSITION (only for 2/2 and 3/2 ways)
	22 = 2 ways		0 = 3 pos. instable
	32 = 3 ways		1 = 3 pos. stable
	52 = 5 ways		CONNECTION TYPE
53 = 5 ways	W		L = Lateral
F 1	FUNCTION (only for 5/3 ways)	P = Rear	FUNCTION (only for 2/2 or 3/2 ways)
	32 = Open centres	F 2	A = Normally Open
	33 = Pressured centres		C = Normally Closed

2/2 - 3/2 - Lateral connections

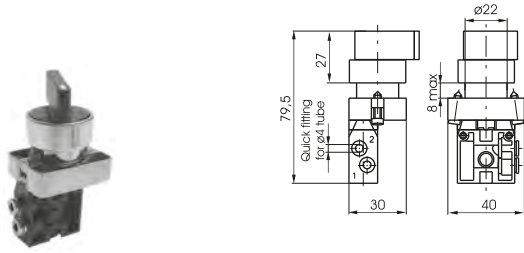

Weight 65 g
Switch 2 positions stable
104. **T**. **F**1.6.27. **L**. **F**

2/2 - 3/2 - Rear connections

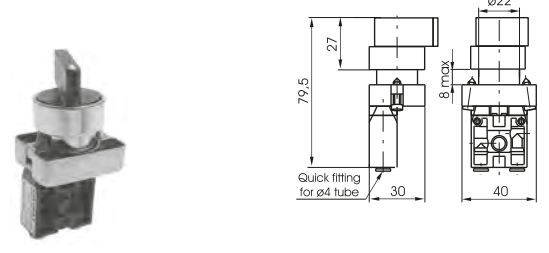

Weight 65 g
Switch 2 positions stable
104. **T**. **F**1.6.27. **P**. **F**

5/2 - Lateral connections

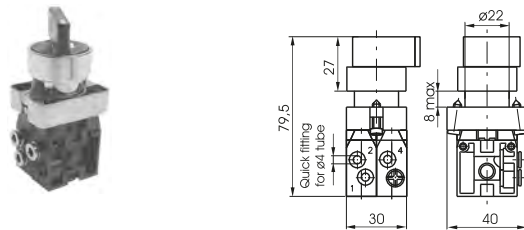

Weight 120 g
Switch 2 positions stable
104.52.6.27.L

5/2 - Rear connections

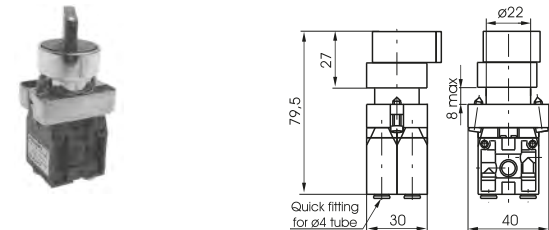

Weight 120 g
Switch 2 positions stable
104.52.6.27.P

5/3 - Lateral connections

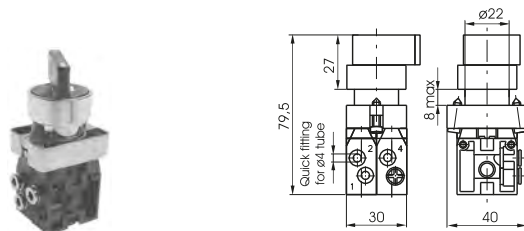

Weight 120 g
104.53. **F**1.6.27. **S**. **L**

5/3 - Rear connections

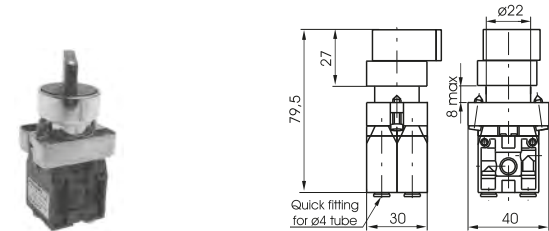

Weight 120 g
104.53. **F**1.6.27. **S**. **P**

1

AIR DISTRIBUTION

Key switch

Coding: 104. **T**. **F** 1.6.28. **S**. **W**. **F** 2

Operational characteristics

Fluid	Filtered air. No lubrication needed, if applied it shall be continuous
Max working pressure (bar)	10
Temperature °C	-5 ÷ +70
Flow rate at 6 bar with Δp=1 (NI/min)	90
Orifice size (mm)	2.5
Working ports size	ø4 tube

T	TYPE	SWITCH POSITION (only for 2/2 and 3/2 ways)	
	22 = 2 ways	0 = 3 pos. instable	
	32 = 3 ways	1 = 3 pos. stable	
F 1	52 = 5 ways	CONNECTION TYPE	
	53 = 5 ways		L = Lateral
	FUNCTION 1 (only for 5/3 ways)		P = Rear
F 2	32 = Open centres	FUNCTION 2 (only for 2/2 or 3/2 ways)	
	33 = Pressured centres	A = Normally Open	
		C = Normally Closed	

AIR DISTRIBUTION

2/2 - 3/2 - Lateral connections

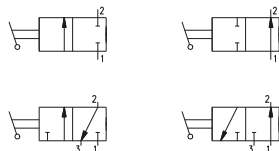
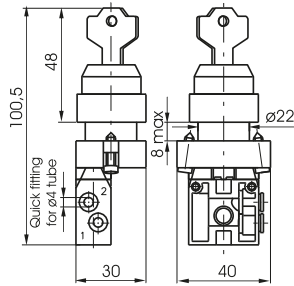

Weight 100 g
Switch 2 positions stable

104. **T**. 6.28. **L**. **F**

2/2 - 3/2 - Rear connections

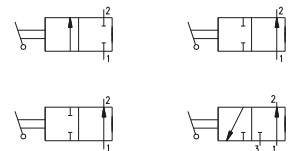
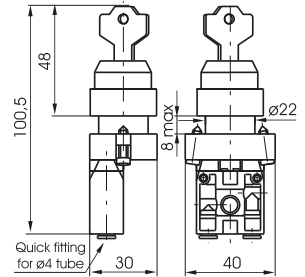

Weight 100 g
Switch 2 positions stable

104. **T**. 6.28. **P**. **F**

5/2 - Lateral connections

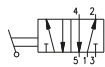
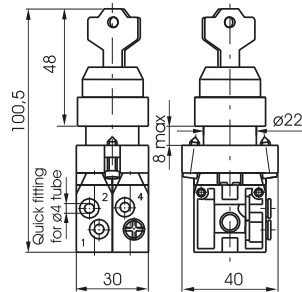

Weight 155 g
Switch 2 positions stable

104.52.6.28.L

5/2 - Rear connections

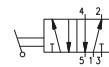
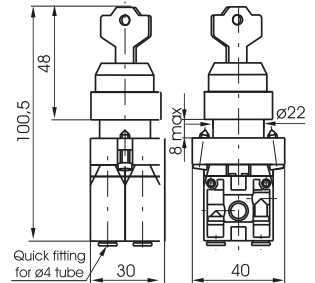

Weight 155 g
Switch 2 positions stable

104.52.6.28.P

5/3 - Lateral connections

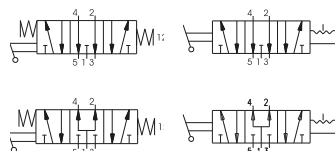
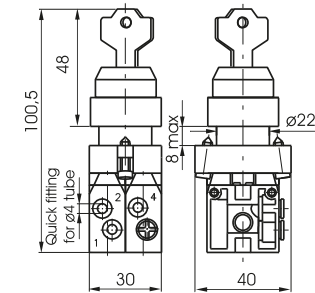

Weight 155 g

104.53. **F**. 6.28. **S**. **L**

5/3 - Rear connections

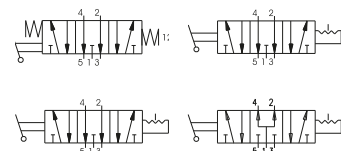
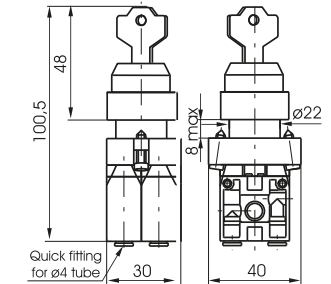

Weight 155 g

104.53. **F**. 6.28. **S**. **P**

Lever roller - Spring

Coding: 104. **T**.2.1. **W**. **F**

Operational characteristics	
Fluid	Filtered air. No lubrication needed, if applied it shall be continuous
Max working pressure (bar)	10
Temperature °C	-5 ÷ +70
Flow rate at 6 bar with Δp=1 (NI/min)	90
Orifice size (mm)	2.5
Working ports size	ø4 tube

T	TYPE
	22 = 2 ways 32 = 3 ways
W	CONNECTION TYPE
	L = Lateral
	P = Rear

F	FUNCTION
	A = Normally Open
	C = Normally Closed

2/2 - 3/2 - Lateral connections

Weight 31 g
Operating force 9 N

104. **T**.2.1.L. **F**

2/2 - 3/2 - Rear connections

Weight 31 g
Operating force 9 N

104. **T**.2.1.P. **F**

Lever roller ball bearing - Spring

Coding: 104. **T**.2.1/1. **W**. **F**

Operational characteristics	
Fluid	Filtered air. No lubrication needed, if applied it shall be continuous
Max working pressure (bar)	10
Temperature °C	-5 ÷ +70
Flow rate at 6 bar with Δp=1 (NI/min)	90
Orifice size (mm)	2.5
Working ports size	ø4 tube

T	TYPE
	22 = 2 ways 32 = 3 ways
W	CONNECTION TYPE
	L = Lateral
	P = Rear

F	FUNCTION
	A = Normally Open
	C = Normally Closed

2/2 - 3/2 - Lateral connections

Weight 46 g
Operating force 9 N

104. **T**.2.1/1.L. **F**

2/2 - 3/2 - Rear connections

Weight 46 g
Operating force 9 N

104. **T**.2.1/1.P. **F**

Lever unidirectional - Spring

Coding: 104. **T**.3.1. **W**. **F**

Operational characteristics	
Fluid	Filtered air. No lubrication needed, if applied it shall be continuous
Max working pressure (bar)	10
Temperature °C	-5 ÷ +70
Flow rate at 6 bar with Δp=1 (NI/min)	90
Orifice size (mm)	2.5
Working ports size	ø4 tube

T	TYPE
	22 = 2 ways 32 = 3 ways
W	CONNECTION TYPE
	L = Lateral
	P = Rear

F	FUNCTION
	A = Normally Open
	C = Normally Closed

2/2 - 3/2 - Lateral connections

Weight 31 g
Operating force 9 N

104. **T**.3.1.L. **F**

2/2 - 3/2 - Rear connections

Weight 31 g
Operating force 9 N

104. **T**.3.1.P. **F**

1
AIR DISTRIBUTION

▶ Complete lever roller operator

Coding: 104.2.1



▶ Complete lever unidirectional

Coding: 104.3.1



▶ Push button

Coding: 104.6.22/ⓐ



BUTTON COLOR	
ⓐ	1 = Red
	2 = Black
	3 = Green
	4 = Yellow

▶ Push button 2 positions

Coding: 104.6.31

(step - step)



▶ Switch - short lever

Coding: 104.6.30.Ⓢ



SWITCH POSITION (only for 3 position)	
Ⓢ	0 = 3 pos. instable
	1 = 3 pos. stable

Switch 2 positions stable 104.6.30

Switch 3 positions 104.6.30.Ⓢ

▶ Key switch

Coding: 104.6.28.Ⓢ



SWITCH POSITION (only for 3 position)	
Ⓢ	0 = 3 pos. instable
	1 = 3 pos. stable

Switch 2 positions stable 104.6.28

Switch 3 positions 104.6.28.Ⓢ

▶ Contact electric element

Coding: 104.ⓕ



FUNCTION	
ⓕ	NO = Normally Open
	NC = Normally Closed

▶ Push button protection cover

Coding: 104.02



▶ Complete lever roller ball bearing operator

Coding: 104.2.1/1



▶ Fixing plate

Coding: 104.00



▶ Raised Push button

Coding: 104.6.23/ⓐ



BUTTON COLOR	
ⓐ	1 = Red
	2 = Black
	3 = Green
	4 = Yellow

▶ Palm button 2 position

Coding: 104.6.25

Emergency - Rotate to unlock



▶ Switch - long lever

Coding: 104.6.27.Ⓢ



SWITCH POSITION (only for 3 position)	
Ⓢ	0 = 3 pos. instable
	1 = 3 pos. stable

Switch 2 positions stable 104.6.27

Switch 3 positions 104.6.27.Ⓢ

▶ Joystick selector switch

Coding: 104.6.39.Ⓢ



▶ Complete Pneumatic Operator

Coding: 104.11



Pneumatic - Spring

Coding: 104. **T**.11.1. **W**. **F**

Operational characteristics	
Fluid	Filtered air. No lubrication needed, if applied it shall be continuous
Max working pressure (bar)	10
Temperature °C	-5 ÷ +50
Flow rate at 6 bar with Δp=1 (Nl/min)	90
Orifice size (mm)	2.5
Working ports size	ø4 tube
Pilot ports size	M5

T	TYPE
	22 = 2 ways 32 = 3 ways
W	CONNECTION TYPE
	L = Lateral
	P = Rear

F	FUNCTION
	A = Normally Open
	C = Normally Closed

2/2 - 3/2 - Lateral connections

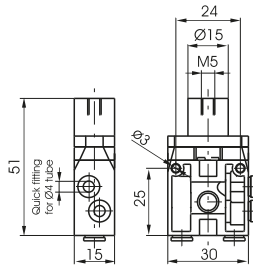

Weight 25 g
Minimum piloting pressure 2,5 bar

104.22.11.1.L. **F**

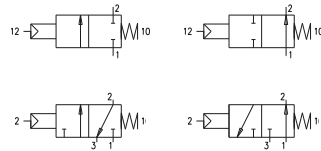

2/2 - 3/2 - Rear connections

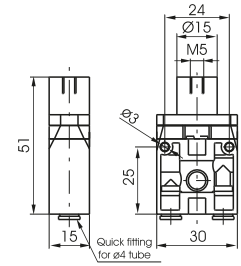

Weight 25 g
Minimum piloting pressure 2,5 bar

104.32.11.1.P. **F**

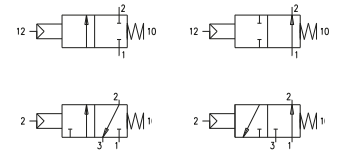

1

AIR DISTRIBUTION