



Series 600 - M5 - G1"

General

These accessories are a range of devices for completing a pneumatic circuit. These valves, with their special functions, are inserted between two valves, between a valve and a cylinder, or following a cylinder.

One of the particular characteristic of these accessories is that they are automatically actuated without the need for external commands. Usually, operation and idle are controlled by the presence or absence of pressure as, for example, in the case of quick exhaust valves which pilots itself as a selector, changing the flow direction as the signal goes off and on.

On the other hand, other components are inert. That is, they do not have any internal variable function which is sensitive to pressure. Among these components are silencers, manifolds and flow regulators.

There are also the flow regulators, which like electronic components, can be defined as variable resistences. They are fundamental in regulating the flow rate, provide precise timings and regulate the cylinders' speed.

The selector valves, with "AND" and "OR" functions, are logic functions components which often are an essential element. Furthermore, they are built to allow high flow rate which cannot be obtained by classic pneumatic logic.

The block valves lock the cylinder in a position, avoiding unexpected depressurization of the cylinder's chamber due to lack of compressed air at the inlet port. Practically, it is a piloted unidirectional valve that blocks the exhaust port when there is no air in the pilot circuit.

Finally the economizer valves are in fact a pressure reducer valves installed between valve and cylinder for reducing the air consumption. For example this is applicable on the cylinder return stroke without penalizing the exhaust as happens with FRL pressure regulator.

Construction characteristics

We have not listed all different materials used for the construction of these components because the list would be too the long. We use corrosion proof material, brass or anodized aluminium and the most appropriate specific mixture for seals. If more information is required please contact our technical department.

Use and maintenance

In operation pay attention to the minimum and maximum criteria for temperature and pressure, and ensure good quality compressed air. In a dirty environment, protect the exhaust ports.

In this case, maintenance is minimal and is necessary only if the air is particularly dirty.

The components most subject to damage by the accumulation of dirt are flow regulators with fine regulation and silencers. As for regulators, follow the normal procedure for disassembling, washing with non-chemical cleaning agents and remounting. The silencers need only to be rinsed in petrol or solvent and blown dry with compressed air.

The number of requests for spare seals for flow regulators and shuttle valves are statistically irrelevant. More often, it is necessary to replace the lining of the quick exhaust because of the wear it undergoes due to the particular conditions of operating.

ATTENTION: use hydraulic oil class H for lubrication such as MAGNA GC 32 (Castrol).

Miniature flow control valve M5 - Ø3 tube

Coding: 6.01.305. **F**

Operational characteristics	
Fluid	Filtered air. No lubrication needed, if applied it shall be continuous
Max working pressure (bar)	10
Temperature °C	-5 ÷ +70
Orifice size (mm)	1.5

FUNCTION	
F 1.2	= Unidirectional
2.1	= Unidirectional
1.1	= Bidirectional

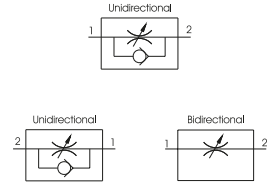
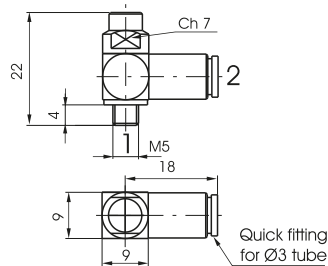

Weight 14 g

Miniature flow control valve M5 - Ø3 tube, with adjustment knob

Coding: 6.01.305. **F**P

Operational characteristics	
Fluid	Filtered air. No lubrication needed, if applied it shall be continuous
Max working pressure (bar)	10
Temperature °C	-5 ÷ +70
Orifice size (mm)	1.5

FUNCTION	
F 1.2	= Unidirectional
2.1	= Unidirectional
1.1	= Bidirectional

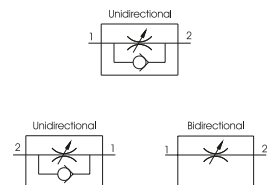
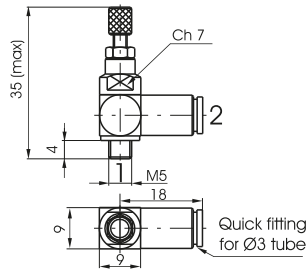

Weight 16 g

Miniature flow control valve M5 - Ø3,17 tube

Coding: 6.01.315. **F**

Operational characteristics	
Fluid	Filtered air. No lubrication needed, if applied it shall be continuous
Max working pressure (bar)	10
Temperature °C	-5 ÷ +70
Orifice size (mm)	1.5

FUNCTION	
F 1.2	= Unidirectional
2.1	= Unidirectional
1.1	= Bidirectional

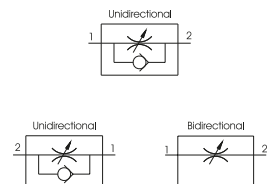
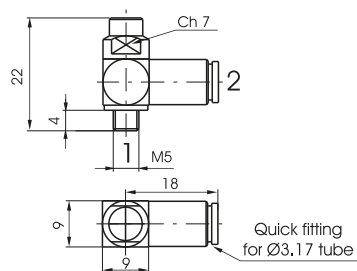

Weight 14 g

Miniature flow control valve M5 - Ø3,17 tube, with adjustment knob

Coding: 6.01.315. **F**P

Operational characteristics	
Fluid	Filtered air. No lubrication needed, if applied it shall be continuous
Max working pressure (bar)	10
Temperature °C	-5 ÷ +70
Orifice size (mm)	1.5

FUNCTION	
F 1.2	= Unidirectional
2.1	= Unidirectional
1.1	= Bidirectional

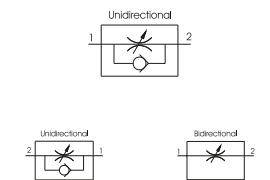
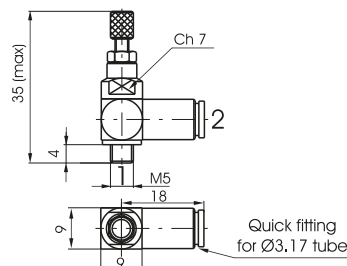

Weight 16 g

► Miniature flow control valve M5 - Ø4 tube

Coding: 6.01.45.ⓕ

Operational characteristics	
Fluid	Filtered air. No lubrication needed, if applied it shall be continuous
Max working pressure (bar)	10
Temperature °C	-5 ÷ +70
Orifice size (mm)	1.5

FUNCTION	
ⓕ 1.2 =	Unidirectional
2.1 =	Unidirectional
1.1 =	Bidirectional

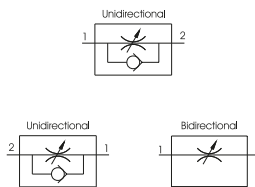
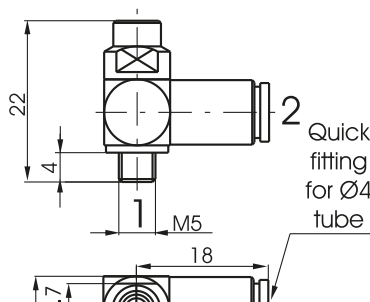

Weight 14 g

► Miniature flow control valve M5 - Ø4 tube, with adjustment knob

Coding: 6.01.45.ⓕP

Operational characteristics	
Fluid	Filtered air. No lubrication needed, if applied it shall be continuous
Max working pressure (bar)	10
Temperature °C	-5 ÷ +70
Orifice size (mm)	1.5

FUNCTION	
ⓕ 1.2 =	Unidirectional
2.1 =	Unidirectional
1.1 =	Bidirectional

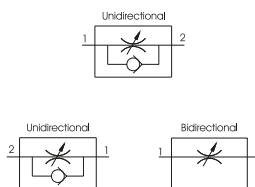
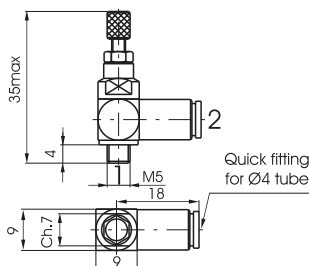

Weight 16 g

► Flow control valve M5 - in line ports

Coding: 6.01.ⓕ

Operational characteristics	
Fluid	Filtered air. No lubrication needed, if applied it shall be continuous
Max working pressure (bar)	10
Temperature °C	-5 ÷ +70
Orifice size (mm)	2

FUNCTION	
ⓕ 05 =	Unidirectional
05/2 =	Bidirectional

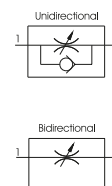
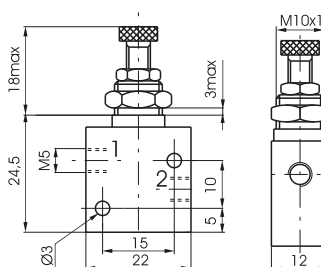

Weight 48 g

► Flow control valve M5 - port at 90°

Coding: 6.01.05.ⓕ

Operational characteristics	
Fluid	Filtered air. No lubrication needed, if applied it shall be continuous
Max working pressure (bar)	10
Temperature °C	-5 ÷ +70
Orifice size (mm)	2

FUNCTION	
ⓕ 90 =	Unidirectional
90/2 =	Bidirectional

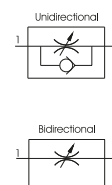
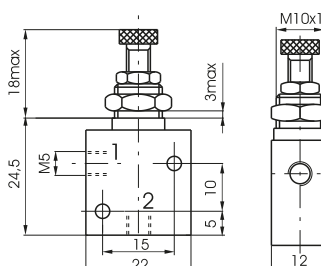

Weight 48 g

▶ Flow control valve M5 - with a through bolt

Coding: 6.01.05. **F**

Operational characteristics	
Fluid	Filtered air. No lubrication needed, if applied it shall be continuous
Max working pressure (bar)	10
Temperature °C	-5 ÷ +70
Orifice size (mm)	2

FUNCTION	
F 180 =	Unidirectional
180/2 =	Bidirectional

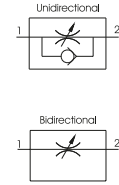
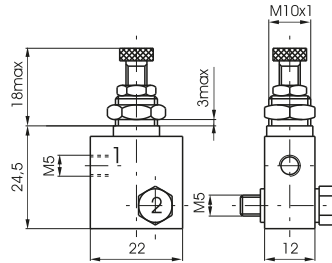

Weight 52 g

▶ Flow control valve G1/8" - ultrasensitive

Coding: 6.01.18/ **F**

Operational characteristics	
Fluid	Filtered air. No lubrication needed, if applied it shall be continuous
Max working pressure (bar)	10
Temperature °C	-5 ÷ +70
Orifice size (mm)	3

FUNCTION	
F 4 =	Unidirectional
5 =	Bidirectional

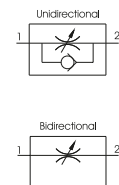
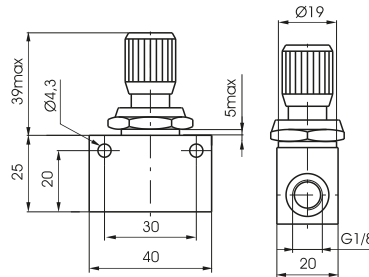

Weight 100 g

▶ Flow control valve G1/8" - ultrasensitive with lock nut

Coding: 6.01.18/ **F**

Operational characteristics	
Fluid	Filtered air. No lubrication needed, if applied it shall be continuous
Max working pressure (bar)	10
Temperature °C	-5 ÷ +70
Orifice size (mm)	3

FUNCTION	
F 6 =	Unidirectional
7 =	Bidirectional

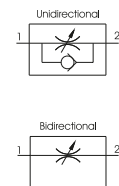
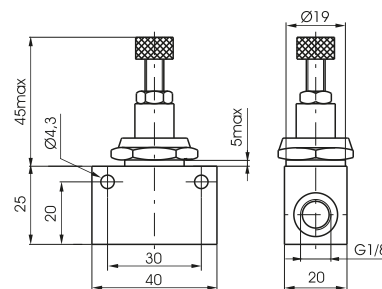

Weight 105 g

▶ Flow control valve G1/8"

Coding: 6.01. **F**

Operational characteristics	
Fluid	Filtered air. No lubrication needed, if applied it shall be continuous
Max working pressure (bar)	10
Temperature °C	-5 ÷ +70
Orifice size (mm)	4

FUNCTION	
F 18N =	Unidirectional
18NE =	Bidirectional
18/1N =	Unidirectional economic version
18/1NE =	Bidirectional economic version

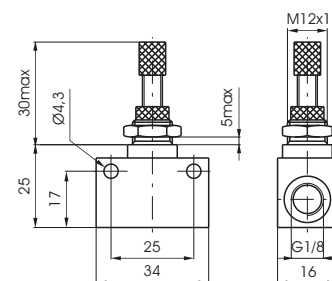

Weight 50 g

Flow control valve G1/4" - compact type - unidirectional

Coding: 6.01.14/1

Operational characteristics	
Fluid	Filtered air. No lubrication needed, if applied it shall be continuous
Max working pressure (bar)	10
Temperature °C	-5 ÷ +70
Orifice size (mm)	5.5

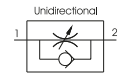
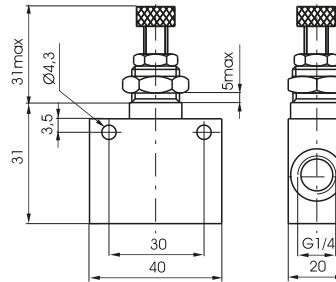

Weight 100 g

Flow control valve G1/4"

Coding: 6.01.F

Operational characteristics	
Fluid	Filtered air. No lubrication needed, if applied it shall be continuous
Max working pressure (bar)	10
Temperature °C	-5 ÷ +70
Orifice size (mm)	7

FUNCTION	
F 14N	= Unidirectional
F 14/1N	= Bidirectional

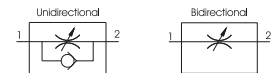
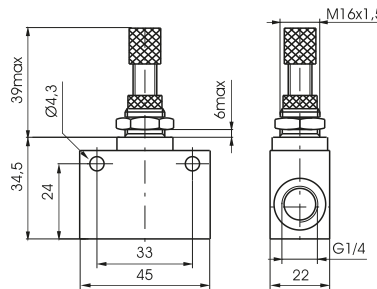

Weight 105 g

Flow control valve G1/2"

Coding: 6.01.F

Operational characteristics	
Fluid	Filtered air. No lubrication needed, if applied it shall be continuous
Max working pressure (bar)	10
Temperature °C	-5 ÷ +70
Orifice size (mm)	12

FUNCTION	
F 12N	= Unidirectional
F 12/1N	= Bidirectional

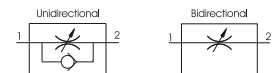
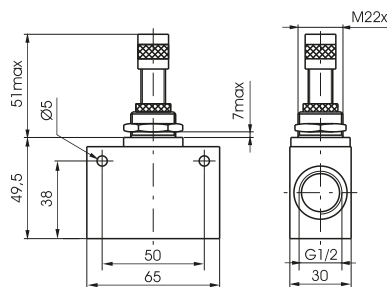

Weight 290 g

Flow control valve G3/4" - unidirectional

Coding: 6.01.34

Operational characteristics	
Fluid	Filtered air. No lubrication needed, if applied it shall be continuous
Max working pressure (bar)	10
Temperature °C	-5 ÷ +70
Orifice size (mm)	12

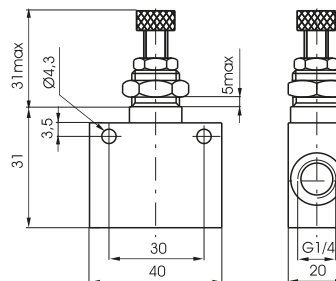

Weight 500 g

1
AIR DISTRIBUTION

AIR DISTRIBUTION

Quick exhaust valve

Coding: 6.02.1

Operational characteristics	
Fluid	Filtered air. No lubrication needed, if applied it shall be continuous
Max working pressure (bar)	0.5÷10
Temperature °C	-5 ÷ +70

CONNECTION (IN)	
05	= M5
18	= G1/8"
14	= G1/4"
12	= G1/2"

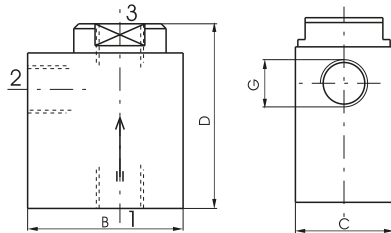

	G	M5	1/8"	1/4"	1/2"
B	22	32	35	52	
C	12	20	25	37	
D	28	38	50	62	
Weight g	50	62	112	310	
Flow rate NI/min at 6 bar with Δp = 1	from 1 to 2	120	480	960	3300
Flow rate NI/min at 6 bar on free exhaust	from 2 to 3	220	1100	1930	6500

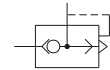

Weight *see table"

Quick exhaust in line valve

Coding: 6.02.1.C.L

Operational characteristics	
Fluid	Filtered air. No lubrication needed, if applied it shall be continuous
Max working pressure (bar)	10
Temperature °C	-5 ÷ +70

CONNECTION (IN)	
M5	= M5
03	= tube Ø3
04	= tube Ø4
06	= tube Ø6
WORKING PORTS SIZE	
M5	= M5
M7	= M7
18	= G1/8"
04	= tube Ø4
06	= tube Ø6

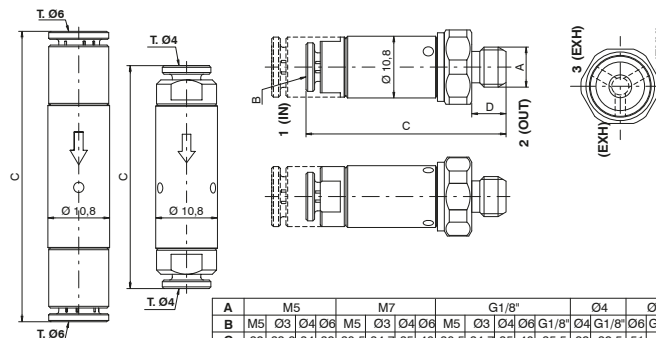

	M5		M7		G1/8"		04	06
A	M5	Ø3	Ø4	Ø6	M5	Ø3	Ø4	Ø6
B	29	33,2	34	39	30,5	34,7	35	40
C	29	33,2	34	39	30,5	34,7	35	40
D	4,5				6			
Weight (g)			17		18		17	20
Flow rate NI/min at 6 bar with Δp=1 (from 1 to 2)	90				110		90	110
Flow rate NI/min at 6 bar on free exhaust (from 2 to 3)	240				350		240	350

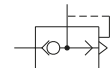

Weight *see table"

Exhaust flow control

Coding: 6.03.1

Operational characteristics	
Fluid	Filtered air. No lubrication needed, if applied it shall be continuous
Max working pressure (bar)	10
Temperature °C	-5 ÷ +70

CONNECTION (IN)	
05	= M5
18	= G1/8"
14	= G1/4"
12	= G1/2"

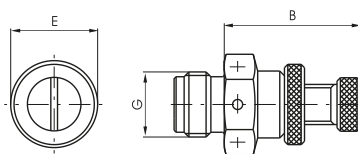

G	M5	1/8"	1/4"	1/2"
B	21	18	22	39
E	9	13	16	25
Weight g	10	18	32	155



Weight *see table"

Shuttle valve "OR"

Coding: 6.04.1

Operational characteristics	
Fluid	Filtered air. No lubrication needed, if applied it shall be continuous
Max working pressure (bar)	10
Temperature °C	-5 ÷ +70

CONNECTION (IN)	
05	M5
18	G1/8"
14	G1/4"

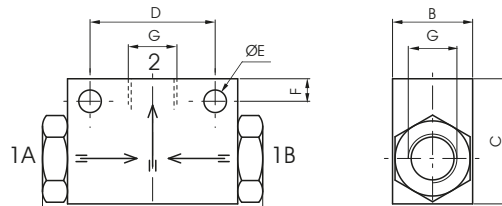

G	M5	1/8"	1/4"
A	27	44	62
B	12	16	22
C	17	25	30
D	15	25	35
E	3,5	4,5	5,5
F	3,5	4,5	5,5
Weight g	33	50	110

Flow rate at 6 bar with $\Delta p = 1$

Nl/min.	110	700	2200
---------	-----	-----	------

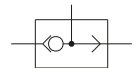

Weight "see table"

Shuttle valve "OR" - T=4

Coding: 6.04.04

Operational characteristics	
Fluid	Filtered air. No lubrication needed, if applied it shall be continuous
Max working pressure (bar)	10
Temperature °C	-5 ÷ +70
Flow rate at 6 bar with $\Delta p = 1$ (Nl/min)	105
Orifice size (mm)	2.5
Working ports size	Fitting T=4

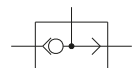
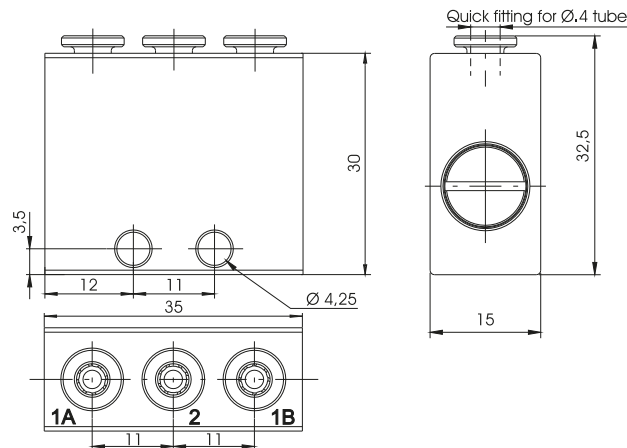

Weight 50g

Shuttle valve "AND"-M5-G1/8"

Coding: 6.04.1/1

Operational characteristics	
Fluid	Filtered air. No lubrication needed, if applied it shall be continuous
Max working pressure (bar)	10
Temperature °C	-5 ÷ +70

CONNECTION (IN)	
05	M5
18	G1/8"

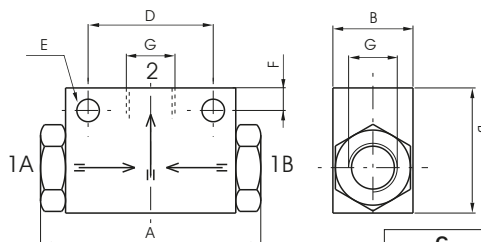

G	M5	1/8"
A	36	44
B	12	16
C	22	45
D	20	25
E	3,2	4,5
F	3,5	4,5
Weight g	30	50

Flow rate at 6 bar with $\Delta p = 1$

Nl/min.	100	480
---------	-----	-----

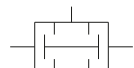

Weight "see table"



AIR DISTRIBUTION

Shuttle valve "AND" - T=4

Coding: 6.04.04/1

Operational characteristics	
Fluid	Filtered air. No lubrication needed, if applied it shall be continuous
Max working pressure (bar)	10
Temperature °C	-5 ÷ +70
Flow rate at 6 bar with Δp=1 (Nl/min)	105
Orifice size (mm)	2.5
Working ports size	Fitting T=4

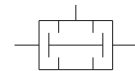
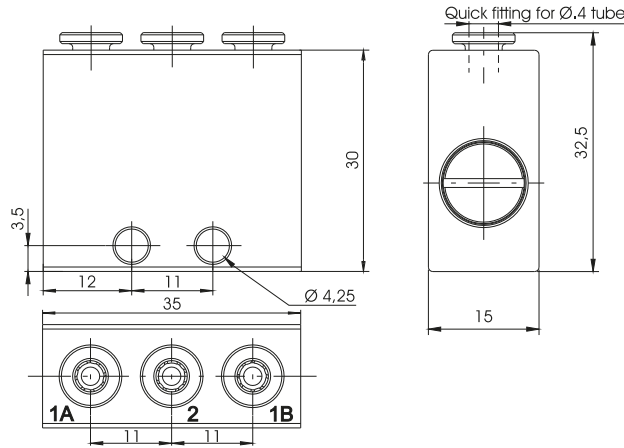

Weight 50 g

Silencers steel wool

Coding: 6.05.1

Operational characteristics	
Fluid	Filtered air. No lubrication needed, if applied it shall be continuous
Max working pressure (bar)	10
Temperature °C	-5 ÷ +70

CONNECTION (IN)	
18	= G1/8"
14	= G1/4"
38	= G3/8"
12	= G1/2"

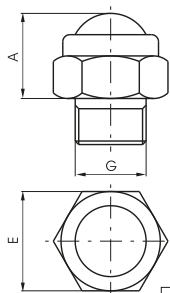

G	1/8"	1/4"	3/8"	1/2"
A	12	13	15	17
E	14	17	22	27
Weight g	8	16	32	44



Weight *see table*

Silencers brass

Coding: 6.06.1

Operational characteristics	
Fluid	Filtered air. No lubrication needed, if applied it shall be continuous
Max working pressure (bar)	10
Temperature °C	-5 ÷ +70

CONNECTION (IN)	
05	= M5
18	= G1/8"
14	= G1/4"
38	= G3/8"
12	= G1/2"
34	= G3/4"
01	= G1"

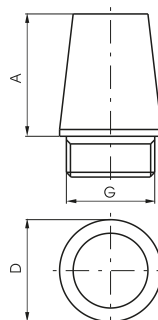

G	M5	1/8"	1/4"	3/8"	1/2"	3/4"	1"
A	17	15	18	28	32	40	50
D	8	12	15	19	23	29	38
Weight g	4	8	15	35	50	92	182



Weight *see table*



G 1/8" compact check valves

Coding: 6.07.18.Ⓒ

Operational characteristics	
Fluid	Filtered air. No lubrication needed, if applied it shall be continuous
Max working pressure (bar)	2,5 ÷ 10
Temperature °C	-5 ÷ +70
Flow rate at 6 bar with Δp=1 (NI/min)	100

SEALS	
Ⓒ R = NBR	
VR = FPM	

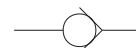
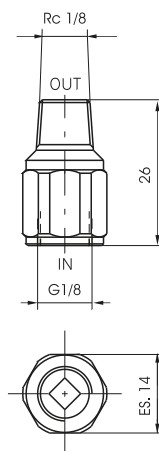

Weight 50 g

Non return valve

Coding: 6.07.Ⓙ

Operational characteristics	
Fluid	Filtered air. No lubrication needed, if applied it shall be continuous
Max working pressure (bar)	10
Temperature °C	-5 ÷ +70 (+150°C FPM)

SEALS	
05 = NBR-M5	
18 = NBR-G1/8"	
14 = NBR-G1/4"	
38 = NBR-G3/8"	
12 = NBR-G1/2"	
18V = FPM-G1/8"	
14V = FPM-G1/4"	
38V = FPM-G3/8"	
12V = in FPM-G1/2"	

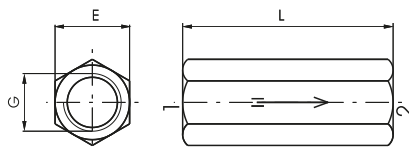

	G	M5	1/8"	1/4"	3/8"	1/2"
E	10	14	17	21	25	
L	21	37	48	50	60	
Weight g	14	35	60	85	136	
Flow rate at 6 bar with Δp = 1	NI/min.	160	650	1150	2600	3500



Weight "see table"

Manifold 4 ports

Coding: 6.08.Ⓒ/4

Operational characteristics	
Fluid	Filtered air. No lubrication needed, if applied it shall be continuous
Max working pressure (bar)	20
Temperature °C	-5 ÷ +70

WORKING PORTS SIZE	
05 = M5	
18 = G1/8"	
14 = G1/4"	
38 = G3/8"	
12 = G1/2"	

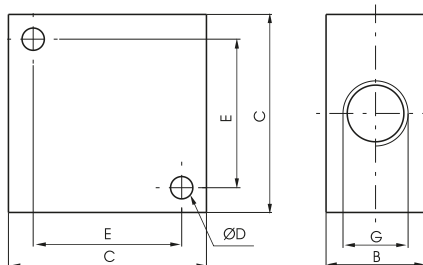
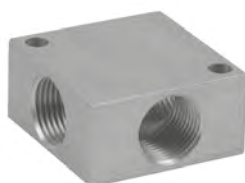

	G	M5	1/8"	1/4"	3/8"	1/2"
B	10	16	20	20	30	
C	20	32	40	40	50	
D	3,3	4,5	4,5	5,5	6,5	
E	14	22	30	30	38	
Weight g	28	38	68	54	135	

Weight "see table"



Manifold 10 ports

Coding: 6.08.Ⓒ/8

Operational characteristics	
Fluid	Filtered air. No lubrication needed, if applied it shall be continuous
Max working pressure (bar)	20
Temperature °C	-5 ÷ +70

WORKING PORTS SIZE	
05	= M5
18	= G1/8"
14	= G1/4"
38	= G3/8"
12	= G1/2"

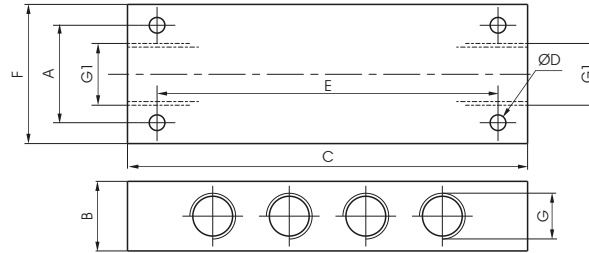

G	M5	1/8"	1/4"	3/8"	1/2"
G1	G1/8"	1/8"	1/4"	3/8"	1/2"
A	16	20	28	28	36
B	12	18	20	20	30
C	60	90	115	130	170
ØD	3,3	4,5	4,5	5,5	5,5
E	50	75	98	112	150
F	22	32	40	40	50
Weight g	92	110	185	165	460

Weight *see table"

Block valve G1/4"

Coding: 6.09.14.Ⓕ

Operational characteristics	
Fluid	Filtered air. No lubrication needed, if applied it shall be continuous
Max working pressure (bar)	10
Maximum piloting pressure (bar)	4
Temperature °C	-5 ÷ +70
Flow rate at 6 bar with Δp=1 (NI/min)	700
Orifice size (mm)	7

FUNCTION	
UN	= Unidirectional
BN	= Bidirectional

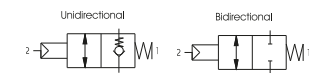
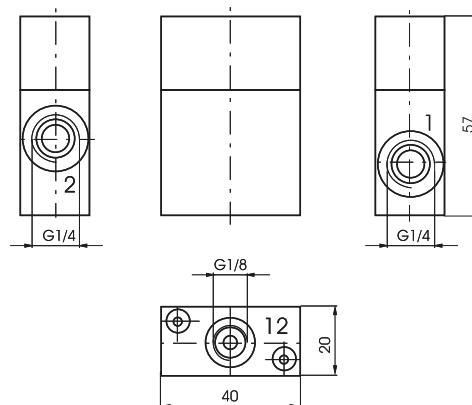

Weight 122 g

Block valve G1/2"

Coding: 6.09.12.Ⓕ

Operational characteristics	
Fluid	Filtered air. No lubrication needed, if applied it shall be continuous
Max working pressure (bar)	10
Maximum piloting pressure (bar)	4
Temperature °C	-5 ÷ +70
Flow rate at 6 bar with Δp=1 (NI/min)	2000
Orifice size (mm)	12

FUNCTION	
UN	= Unidirectional
BN	= Bidirectional

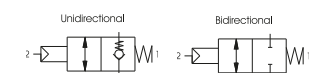
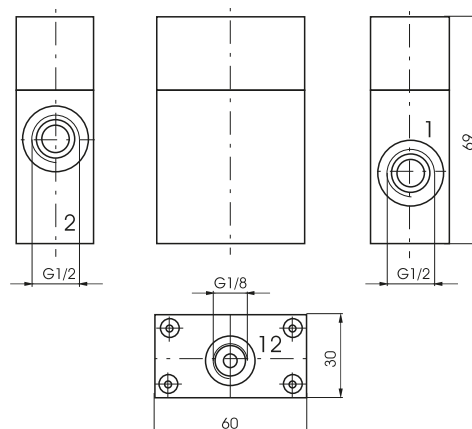

Weight 305 g

AIR DISTRIBUTION

1

Economizer

Coding: 6.11.ⓐ

Operational characteristics	
Fluid	Filtered air. No lubrication needed, if applied it shall be continuous
Max working pressure (bar)	10
Pressure range (bar)	0 ÷ 5,5
Temperature °C	-5 ÷ +70
Flow rate at 6 bar with Δp=1 (NI/min)	860
Orifice size (mm)	6

WORKING PORTS SIZE	
ⓐ	18 = G1/8"
	14 = G1/4"

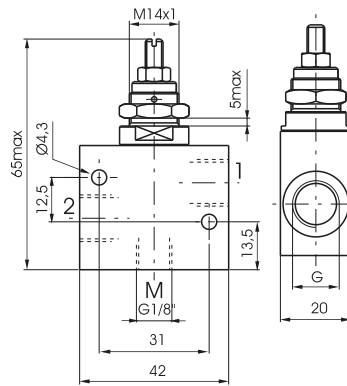

FLOW RATE CURVES
FROM 1 TO 2

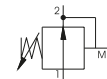
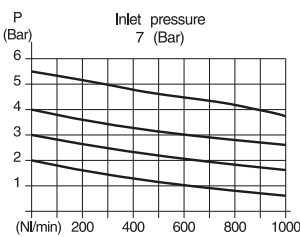

Weight 85 g

1
AIR DISTRIBUTION



Gang mounting manifold for valves and solenoid valves G1/8"

Coding: 6.10.18. S/P

VALVE SIZE	
18	= 18 mm
25	= 25 mm
S 26	= 26 mm
30	= 30 mm
32	= 32 mm
35	= 35 mm
N. POSITIONS	
2	= N. 2 positions
3	= N. 3 positions
4	= N. 4 positions
P 5	= N. 5 positions
6	= N. 6 positions
7	= N. 7 positions
8	= N. 8 positions
9	= N. 9 positions
10	= N. 10 positions

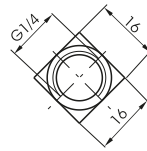
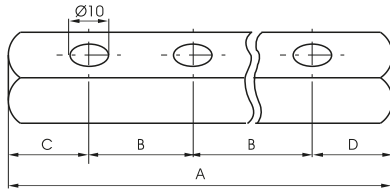

	N. OF POSITIONS									
	2	3	4	5	6	7	8	9	10	
A	58	76	94	112	130	148	166	184	202	
B	18	18	18	18	18	18	18	18	18	
C	20	20	20	20	20	20	20	20	20	
D	20	20	20	20	20	20	20	20	20	
Weight g	55	80	105	130	155	180	205	230	255	

6.10.18.18/P
Weight *see table"

	N. OF POSITIONS									
	2	3	4	5	6	7	8	9	10	
A	70	95	120	145	170	195	220	245	270	
B	25	25	25	25	25	25	25	25	25	
C	20	20	20	20	20	20	20	20	20	
D	25	25	25	25	25	25	25	25	25	
Weight g	80	115	150	185	220	255	290	325	360	

6.10.18.25/P
Weight *see table"

	N. OF POSITIONS									
	2	3	4	5	6	7	8	9	10	
A	66	92	118	144	170	196	222	248	274	
B	26	26	26	26	26	26	26	26	26	
C	20	20	20	20	20	20	20	20	20	
D	20	20	20	20	20	20	20	20	20	
Weight g	70	110	145	185	220	260	300	340	375	

6.10.18.26/P
Weight *see table"

	N. OF POSITIONS									
	2	3	4	5	6	7	8	9	10	
A	80	110	140	170	200	230	260	290	320	
B	30	30	30	30	30	30	30	30	30	
C	25	25	25	25	25	25	25	25	25	
D	25	25	25	25	25	25	25	25	25	
Weight g	100	140	180	220	260	300	340	380	420	

6.10.18.30/P
Weight *see table"

	N. OF POSITIONS									
	2	3	4	5	6	7	8	9	10	
A	82	114	146	178	210	242	274	306	338	
B	32	32	32	32	32	32	32	32	32	
C	25	25	25	25	25	25	25	25	25	
D	25	25	25	25	25	25	25	25	25	
Weight g	100	145	190	235	280	325	370	415	460	

6.10.18.32/P
Weight *see table"

	N. OF POSITIONS									
	2	3	4	5	6	7	8	9	10	
A	89	124	159	194	229	264	299	334	369	
B	35	35	35	35	35	35	35	35	35	
C	27	27	27	27	27	27	27	27	27	
D	27	27	27	27	27	27	27	27	27	
Weight g	110	160	210	260	310	360	410	460	510	

6.10.18.35/P
Weight *see table"

1 AIR DISTRIBUTION



Gang mounting manifold for valves and solenoid valves G1/4"

Coding: 6.10.14.S/P

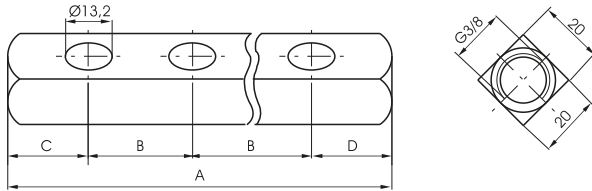

S	VALVE SIZE
	20 = 20 mm
	25 = 25 mm
	30 = 30 mm
	35 = 35 mm
P	N. POSITIONS
	2 = N. 2 positions
	3 = N. 3 positions
	4 = N. 4 positions
	5 = N. 5 positions
	6 = N. 6 positions
	7 = N. 7 positions
	8 = N. 8 positions
	9 = N. 9 positions
	10 = N. 10 positions

1
AIR DISTRIBUTION

	N. OF POSITIONS									
	2	3	4	5	6	7	8	9	10	
A	65	85	105	125	145	165	185	205	225	
B	20	20	20	20	20	20	20	20	20	
C	22,5	22,5	22,5	22,5	22,5	22,5	22,5	22,5	22,5	
D	22,5	22,5	22,5	22,5	22,5	22,5	22,5	22,5	22,5	
Weight g	130	150	190	190	210	230	250	270	290	

6.10.14.20/P
Weight "see table"

	N. OF POSITIONS									
	2	3	4	5	6	7	8	9	10	
A	75	100	125	150	175	200	225	250	275	
B	25	25	25	25	25	25	25	25	25	
C	25	25	25	25	25	25	25	25	25	
D	25	25	25	25	25	25	25	25	25	
Weight g	140	170	200	230	260	290	320	350	380	

6.10.14.25/P
Weight "see table"

	N. OF POSITIONS									
	2	3	4	5	6	7	8	9	10	
A	80	110	140	170	200	230	260	290	320	
B	30	30	30	30	30	30	30	30	30	
C	25	25	25	25	25	25	25	25	25	
D	25	25	25	25	25	25	25	25	25	
Weight g	150	190	230	270	310	350	390	430	470	

6.10.14.30/P
Weight "see table"

	N. OF POSITIONS									
	2	3	4	5	6	7	8	9	10	
A	85	120	155	190	225	260	295	335	365	
B	35	35	35	35	35	35	35	35	35	
C	30	30	30	30	30	30	30	30	30	
D	20	20	20	20	20	20	20	20	20	
Weight g	160	210	260	310	360	410	460	510	560	

6.10.14.35/P
Weight "see table"

	N. OF POSITIONS									
	2	3	4	5	6	7	8	9	10	
A	115	160	205	250	295	340	385	430	475	
B	45	45	45	45	45	45	45	45	45	
C	35	35	35	35	35	35	35	35	35	
D	35	35	35	35	35	35	35	35	35	
Weight g	200	275	350	425	500	575	650	725	800	

6.10.14.45/P
Weight "see table"

Spry valves

Coding: 6.13.00

Construction characteristics

- This valve, is based on the Venturi principle, and it is used to spray and nebulize a liquid.
- Useful in all applications where is needed a continuous lubrication and / or refrigeration.
- Incoming air (connection 1) sucks the liquid through the venturi principle (connection 3) to obtain a continuous spray output (connection 2).

Technical characteristics	
Fluid	Filtered air. No lubrication needed, if applied it shall be continuous
Liquid	Water and oil (Liquid viscosity 3°E-5°E)
Working pressure (bar)	3 ÷ 10
Temperature °C	-5 ÷ +70
Weight (g)	85

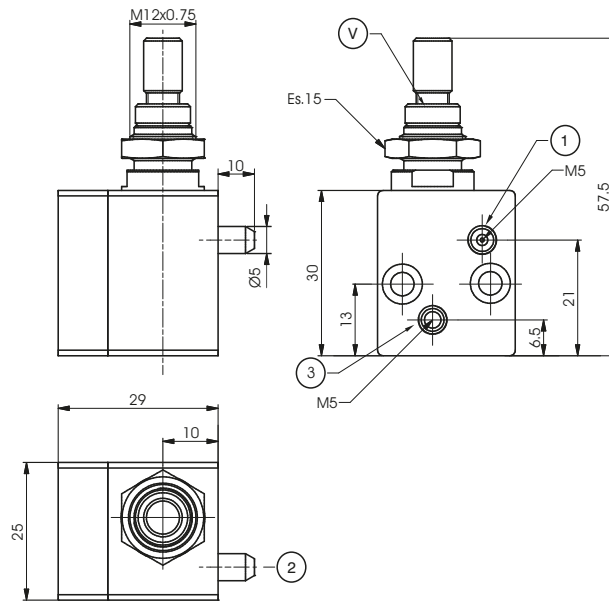

Liquid consumption diagram

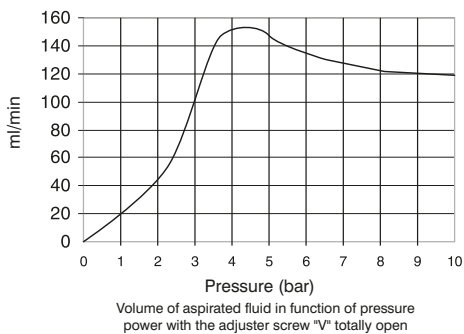

Vacuum diagram

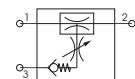
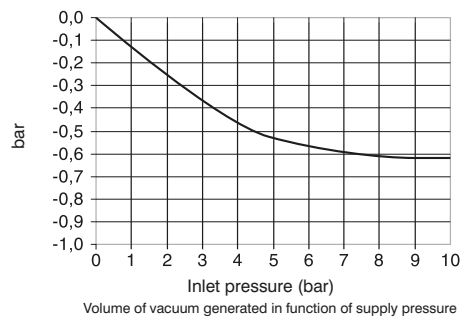

Supply air : Connection 1
Output (air and nebulized liquid) : Connection 2
Supply liquid : Connection 3

1 AIR DISTRIBUTION